

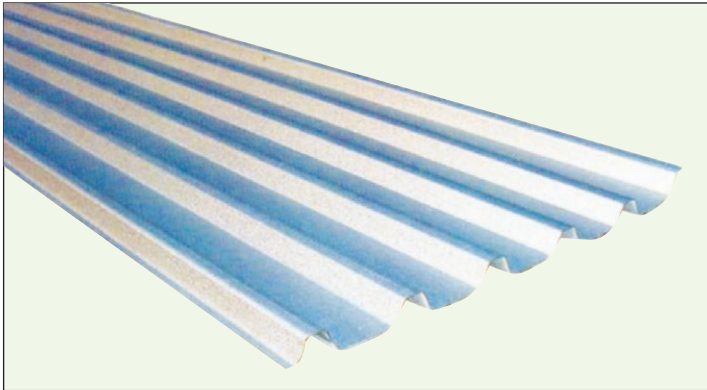

ダブルルーフ

大波スレート屋根改修



製品仕様

型式	ダブルルーフ (大波スレート屋根改修工法) (新築工法)
板幅 働き幅 板厚	914mm幅 650mm(一山重ね) 0.4・0.5・0.6mm
使用材料	ガルバリウム・G Lカラー etc.
裏貼加工	裏面結露防止材(ペフ)4mm 貼り付加工可能
用途	工場・倉庫・鶏舎・牛舎等の 屋根・外装材(改修・新築)

ダブルルーフ用軒先

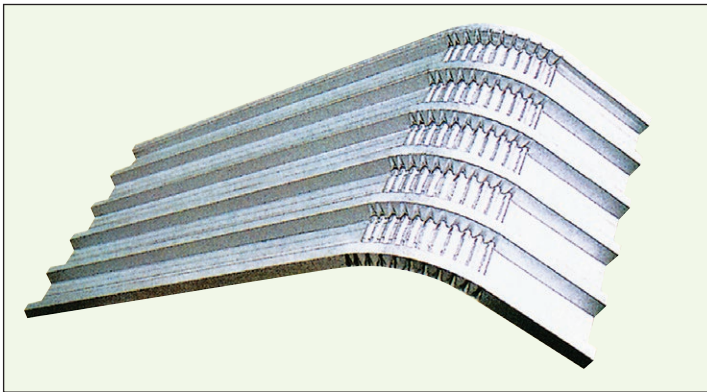

製品断面図

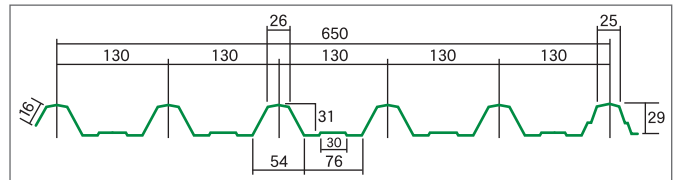

構成図

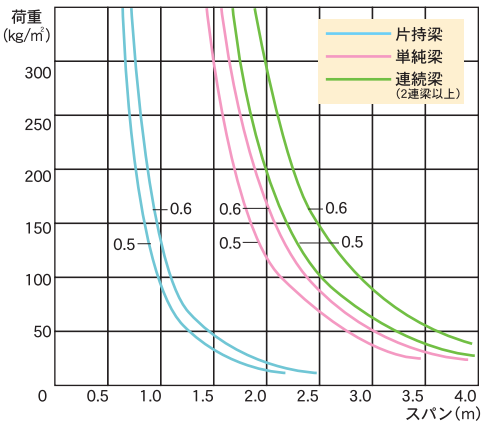
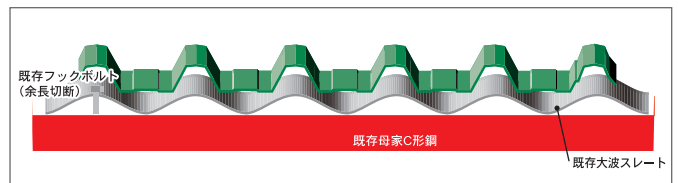

ハット型鋼

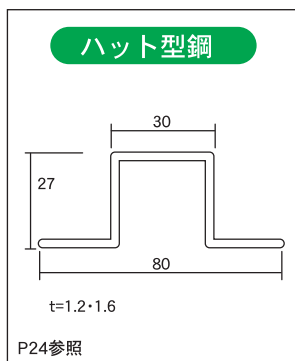

改修用

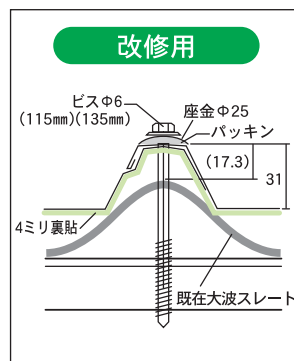

新築用

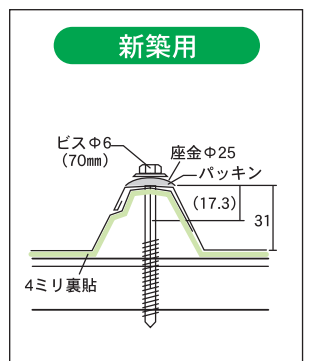

棟

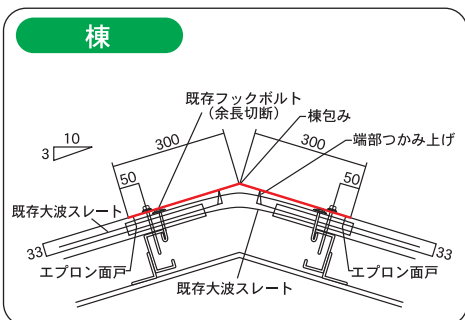

ケラバ

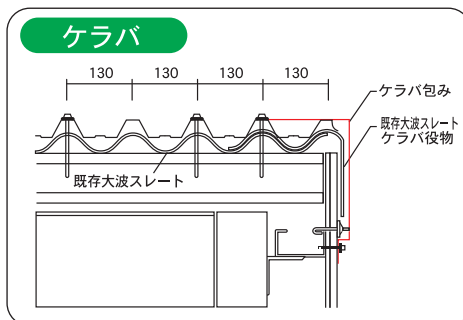

軒先ラジアル

