

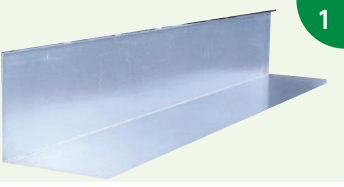
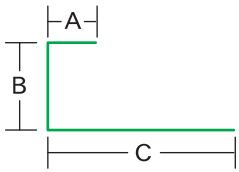

床部材 アクセサリー

1

コンクリート止め

2

コンクリート止め

3

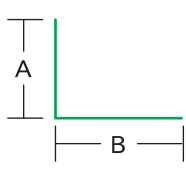
Z型金物



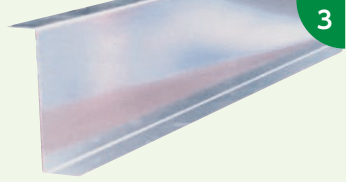
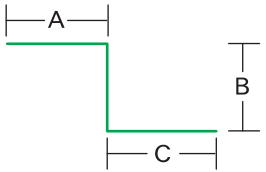

4

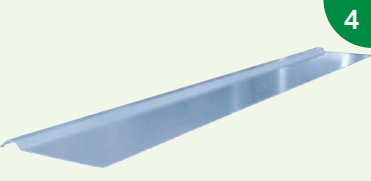
フラッシング



4-1 合成デッキ用



W=90・140・180・240

4-2 一般デッキ用

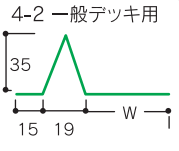

W=65・115・155・215

5

調整プレート

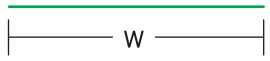
W=200
W=300
W=400

6

控え筋

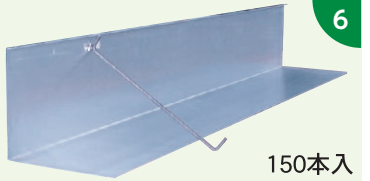

150本入

材料丸棒6φ

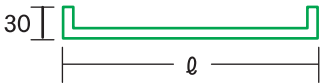

φ=200
φ=300

7

小口塞ぎ

NK-C50

200枚入

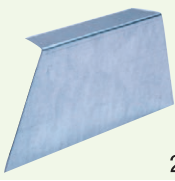
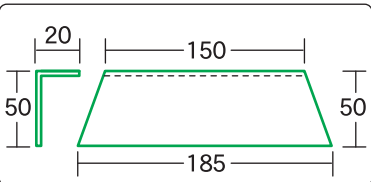



8

小口塞ぎ

NK-C75

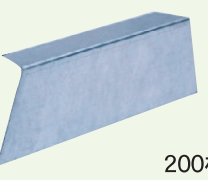
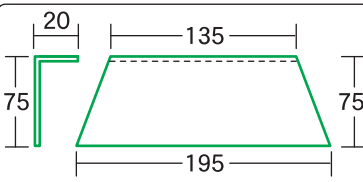
200枚入

9

エンドクローズキーストーン型

オープンタイプ有り

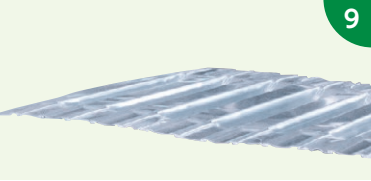
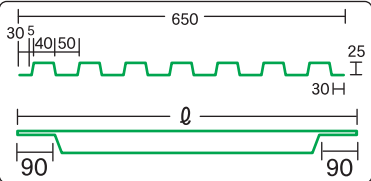
10

エンドクローズアイアンボード

オープンタイプ有り

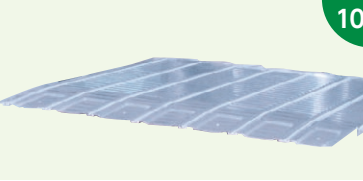
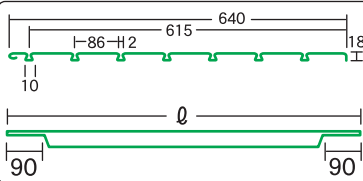
	アエンZ12	電気メッキ
1	t=1.2~t=3.2	t=1.2~t=3.2
2	t=1.2~t=3.2	t=1.2~t=3.2
3	t=1.2~t=3.2	t=1.2~t=3.2
4-1	t=1.2~t=3.2	t=1.2~t=3.2
4-2	t=1.2~t=3.2	t=1.2~t=3.2
5	t=1.2~t=3.2	t=1.2~t=3.2
6	—	—
7	t=1.0	t=0.8
8	t=1.0	t=0.8
9	t=0.8~t=1.2	—
10	t=0.6~t=0.8	—

▶オーダー加工承ります